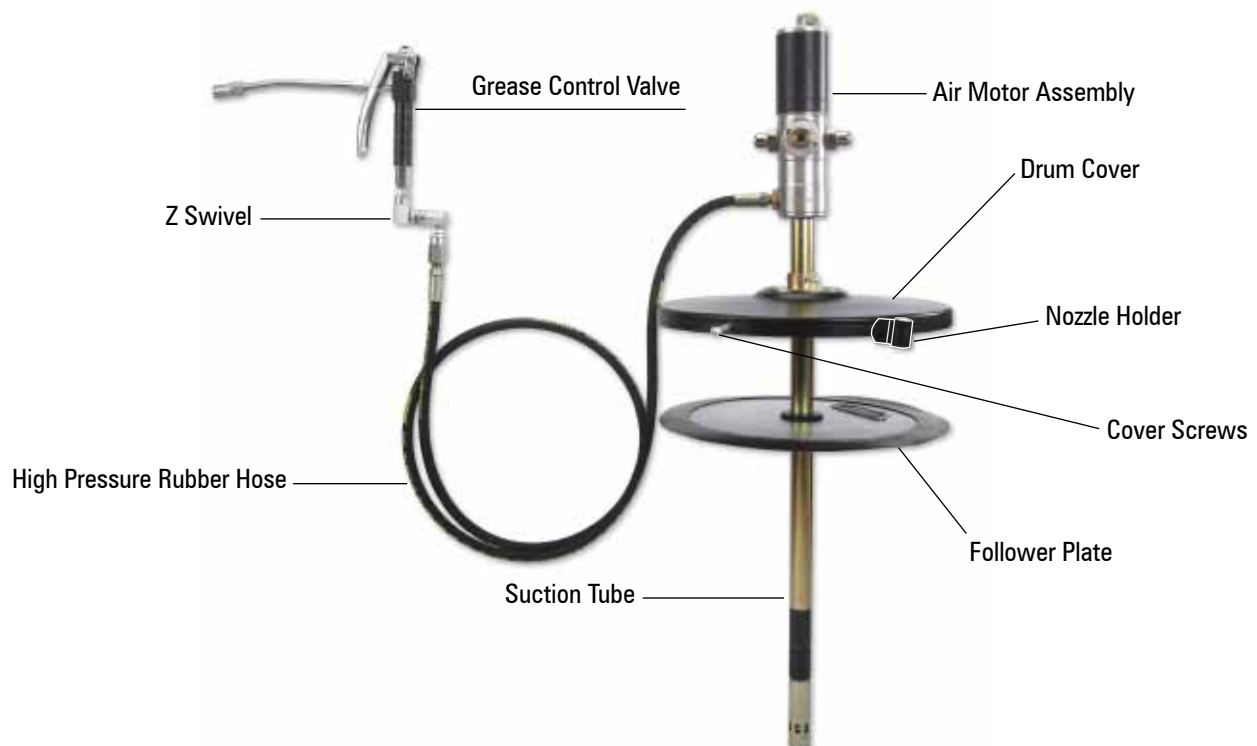

Air Operated Grease Ratio Pumps 50:1

GP1, GP2, GP3

Congratulations on purchase of this World Class Air Operated Grease Ratio Pump !

- World-class Industrial High Pressure Grease pump with guaranteed performance & hassle free operation
- Pump dispenses Grease at pressures upto 50 times the Air inlet pressure
- Designed to work in tough conditions- Ideal for use in Industry, workshop, farm, construction or as part of the Mobile Grease system
- All metal construction, fully CNC machined with hardened wear resistant moving parts
- Reciprocating piston operated 2.5" (63 mm) dia. Air Motor
- Fitted with strainer at suction tube inlet for clean grease to the bearing
- Supplied in two choices :-
 - **Pump Only**
 - **Pump with Drum Cover, Rubber Lined Follower Plate, High Pressure Grease Hose, Z swivel & Professional Grease Control Valve**

Fig.1

Contents

Page No.

PUMP CONSTITUENTS	3
PUMP CONSTRUCTION	3
WORKING OF PUMP	4
INSTALLATION	5
PUMP OPERATION	6
MAINTENANCE & REPAIR	7-11
• Pumping Section Kit Replacement	7-8
• Drive Section Kit Replacement.	9-11
EXPLODED VIEW	12
PARTS LIST	13-14
TROUBLESHOOTING	15
REPLACEMENT & SERVICE PARTS PROGRAM FOR GREASE RATIO PUMP	16-18
• Replacement Parts Program	16
• Service Parts Program (Pumping Section Kit - KIT/BTM/RP-G)	17
• Service Parts Program (Drive Section Kit - KIT/TP/RP-G)	18
SPECIFICATIONS	19
WARNINGS	19

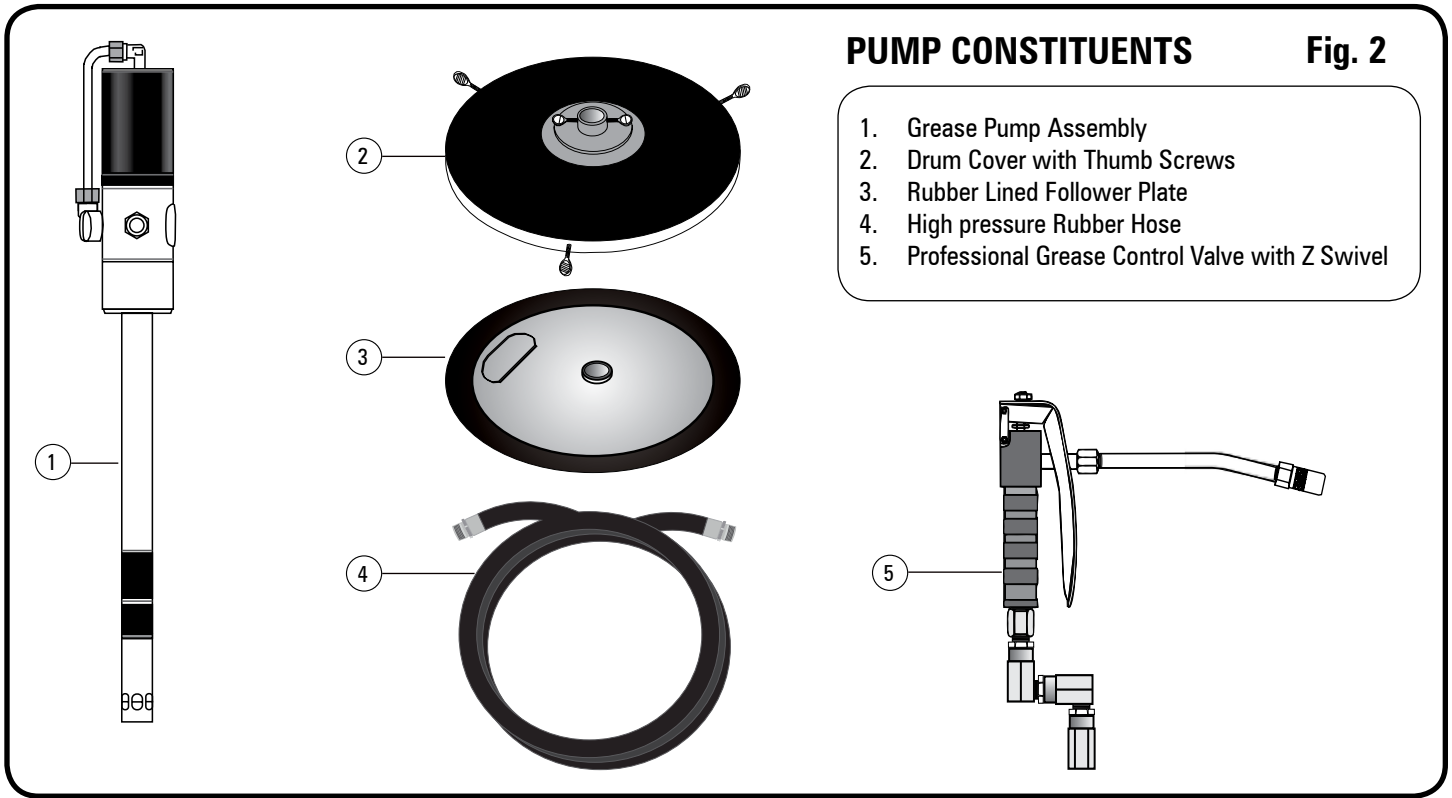

PUMP CONSTITUENTS **Fig. 2**

1. Grease Pump Assembly
2. Drum Cover with Thumb Screws
3. Rubber Lined Follower Plate
4. High pressure Rubber Hose
5. Professional Grease Control Valve with Z Swivel

PUMP CONSTRUCTION

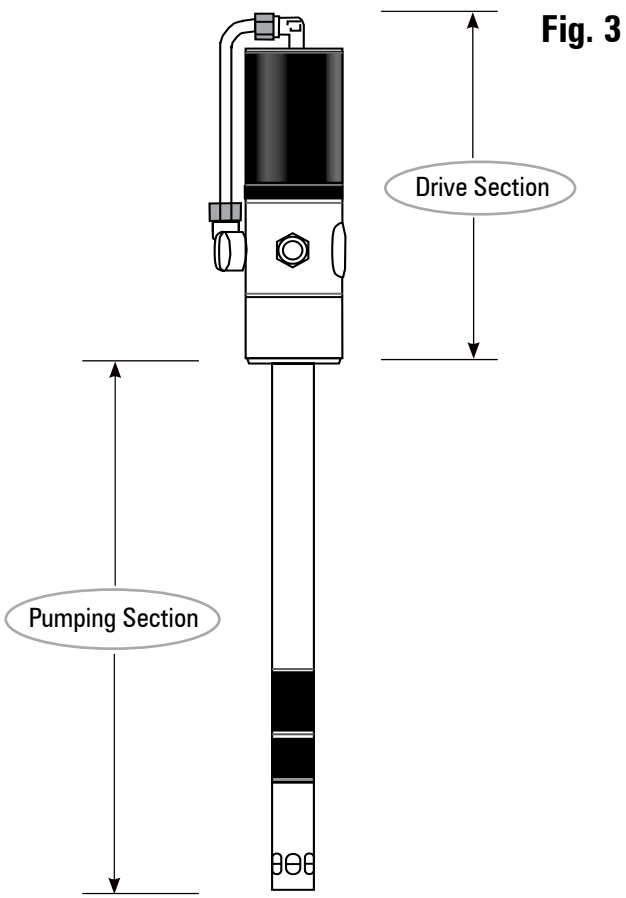

The pump is made up of two sections as given below :-

- **Drive section** :- It consists of an Air Motor Assembly driven by compressed air. The piston diameter of the air motor is 2.5" / 63 mm. The motor consists of an air cylinder with piston and one reciprocal valve with a nylon slider. The valve directs the compressed air alternately to the top or bottom of the piston, thus producing a reciprocating motion of the piston rod.
- **Pumping Section** :- It consists of a pump in which a piston lifts the grease through Non Return Valves by reciprocating inside the pump cylinder. The grease is discharged with pressure (from the outlet located at bottom of Air Motor) into the delivery hose.

NOTE
AIR MOTOR of these pumps starts automatically when the Grease Control Valve is opened. When the valve is closed, Air Motor builds up a back-pressure and stops operating the pumping section.
PRESSURE RATIO of the pump states the ratio of the output grease pressure to the incoming air pressure. When the pressure ratio is 50:1, we achieve an output grease pressure up to 7500 PSI (500 BAR) when the incoming air pressure is 150 PSI (10 BAR).

WORKING OF PUMP

UPSTROKE Fig. 4

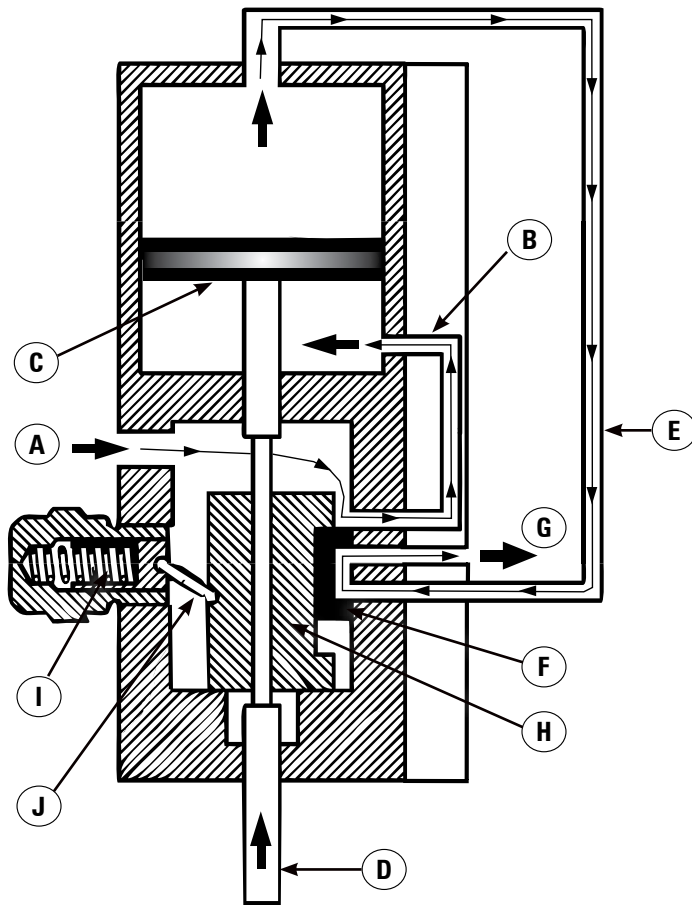

UPSTROKE -

When Grease Control Valve is opened, compressed air enters at arrow A and passes through passage B to the underside of the Piston C, driving the Piston C and Piston Rod D upwards. The air above the Piston is evacuated through passage E, past the Slider Valve F and out at arrow G. The Piston approaches top dead centre and Piston Rod D makes contact with the Slider Rod H. Now the Slider Rod H starts moving up with the Piston Rod D.

DOWNSTROKE Fig. 5

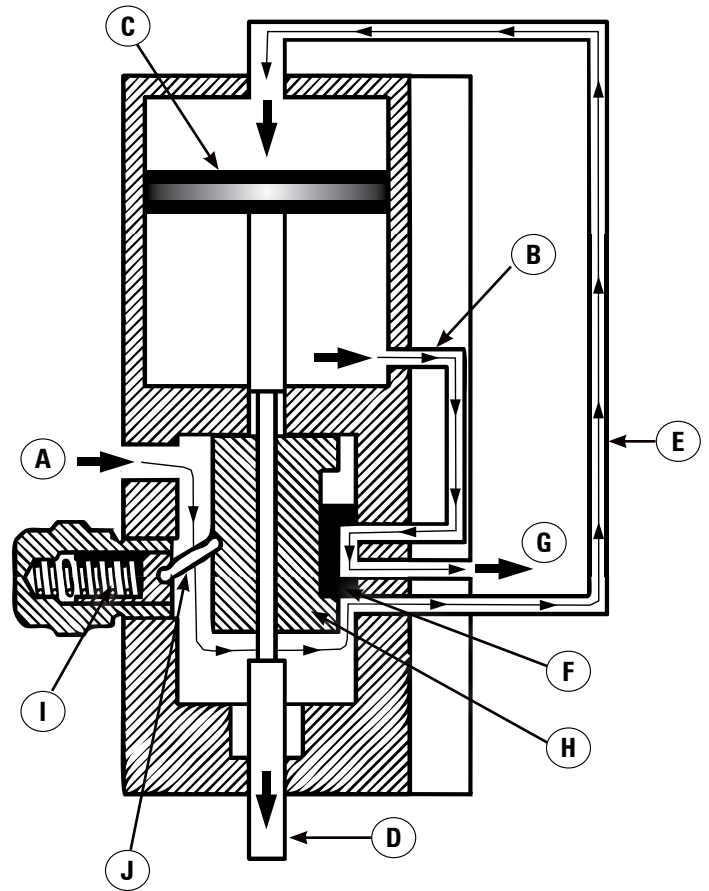

DOWNSTROKE -

The incoming air is now led via passage E to the upper side of Piston C, driving it and the Piston Rod D downwards. The air under the Piston C is evacuated through passage B, past the Slider Valve F and out at arrow G. The Piston approaches bottom dead centre and Piston rod D makes contact with the Slider Rod H. When Slider Rod H passes its centre position, the Pusher Spring I and Pusher Button J snap it over to its lower position.

The air motor repeats Upstroke & Downstroke in continuous cycle to produce a reciprocating motion, driven by compressed air. This motion is transferred via a connecting rod to the piston in the Pumping Section. During every upstroke, non return valves (with spring & ball check) get opened & the piston lifts the grease. During every downstroke, non return valves get closed & the piston discharges grease from the outlet valve. Closing the Grease Control Valve shuts off the air motor & pump stops dispensing grease.

INSTALLATION

NOTE

An FRL (Filter-Regulator-Lubricator) unit must be used in the Air supply, before it is connected to the pump. Set the regulator to 6 BAR (90 PSI) or any required inlet pressure, but never more than 150 PSI (10 BAR) or less than 30 PSI (2 BAR).

1. Fill the drum with Grease leaving empty space of about 2" from the top rim. Shake the drum after it is filled to remove air pockets. Place the follower plate in the grease drum with the lift handle facing upwards. Push the follower plate down, until some grease is forced through the centre hole on the plate.

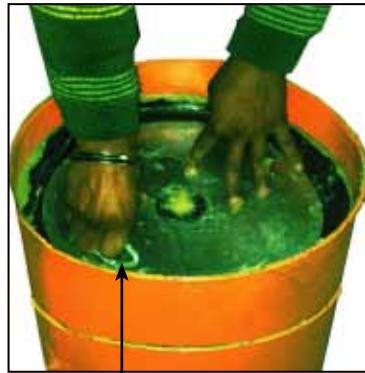

Lift Handle

2. Place the drum cover on the drum. Lift the pump assembly & slide the suction tube through the drum cover & centre hole in the follower plate.



3. Push the pump assembly down till the bottom of the pump touches the base of the drum. Adjust the drum cover and tighten it with the thumb screws provided along with the drum cover.



Thumb Screw

4. Tighten the drum cover with the pump suction tube with the help of thumb screws.

Thumb Screws

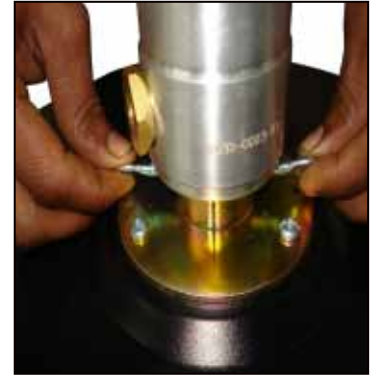
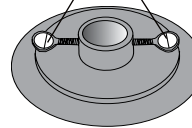

5. Use a wrench to tighten high pressure hose to the pump outlet.



Hose

6. Use a wrench to tighten the other end of the hose to Z Swivel of grease control valve. Tighten the outlet extension & coupler to the control valve outlet. Use thread sealant on all connections to ensure leak-proof working.

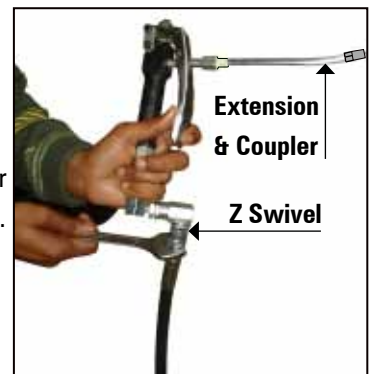

Extension & Coupler

Z Swivel

7. With the air supply turned off, connect the Air line into the air inlet on the pump.



Air Line

PUMP OPERATION

1. Partially open the on/off air valve (It helps in creating initial vacuum when filling a totally dry pump). Pump will start operating automatically until it gets primed. Pump is said to be **Primed** when grease is available at the pump outlet, making the pump ready to use. Once primed, the air motor will stop. Open the on/off air valve fully.
 2. Hold the grease control valve near a container & press the trigger. Pump will start operating with continuous grease discharge as long as the trigger is pressed. Release the trigger & this will stop the pump. Check for any leaks from any of the connections & Tighten again if required.
- 
- The image shows a close-up of a person's hand holding a metal grease control valve. The valve has a trigger mechanism on the handle. A metal hose is connected to the side of the valve, leading to a grease nipple. The background is plain white.
3. Connect coupler fitted onto the control valve extension with the grease nipple & press trigger. Be careful not to over-lubricate as the pump will keep dispensing grease as long as the trigger is pressed. Once the trigger is released, pump will stop dispensing grease & the air motor will stop.
 4. When not in use & at the end of each day, air supply to the pump must be switched off.
-

MAINTENANCE & REPAIR (Refer to Exploded View - Page 12)

Service Precautions

- Before performing any service operation, always shut off the air supply and release the pressure of the medium, i.e. let the grease out so that the pressure decreases. When storing the pump assembly without the bucket, cover the Filter Tube (57) with Filter Cap (62).
- Be careful not to damage any parts when dismantling. While removing shafts which do not have key flats, use a Pipe wrench, Polygrip wrench or the like. The easiest way to remove such a shaft is to grip it in a vice with aluminium or copper jaws, clamp the shaft in a hand-drill chuck and then turn the chuck by hand.
- Be careful when fitting O-rings and seals. Always lubricate them with grease before fitting. They must never be threaded over sharp edges when being fitted. Lubricate all moving parts with synthetic grease. Apply minor locking fluid on all threaded joints.
- When troubleshooting, be on a lookout for dirt in valves / ball seats, scratches in sealing surfaces & damaged O-rings / seals / gaskets.

Recommended Tools

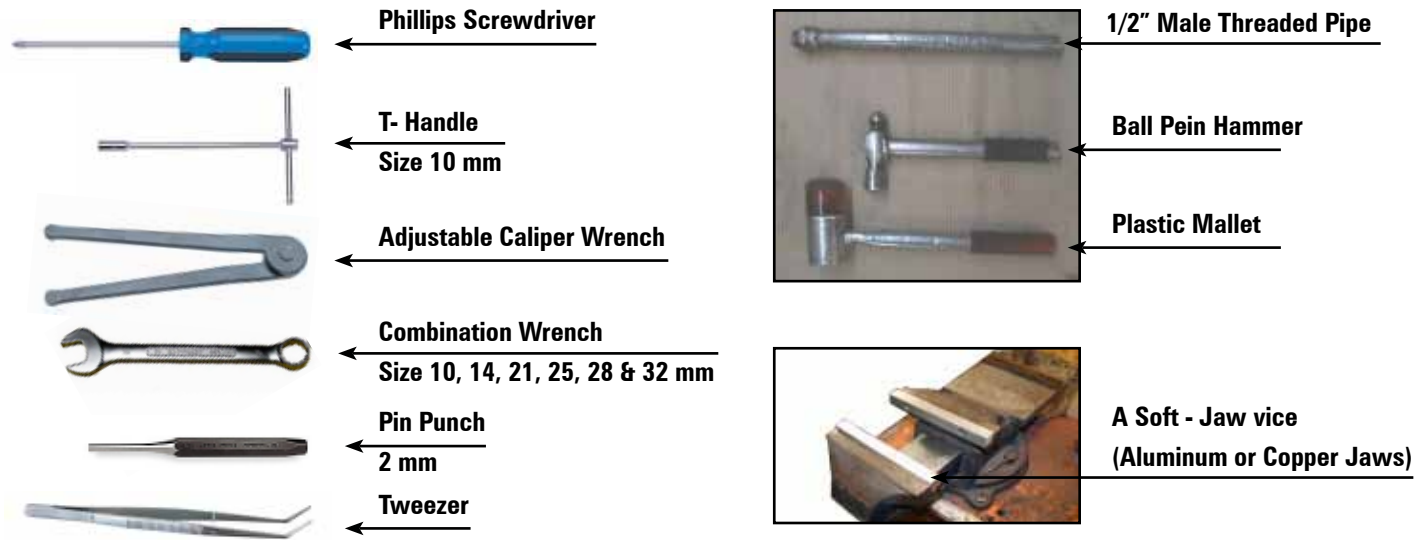

Pumping Section Kit Replacement (Refer to Table 5 - Page 17)

1. Hold Barrel (63) in a soft-jaw vice. Pull out Filter Cap (62) by hand.

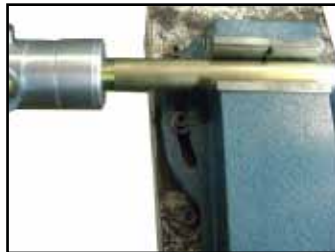

3. Unscrew Top Coupler (52) using wrench (size 28 mm) on the given flats. Remove lower coupler assembly.



Lower Coupler Assembly



2. Unscrew Nyloc Nut (61) using T-handle (size 10 mm) & also remove Piston Washer (60) from the end of Filter Tube (57).



4. Remove the outlet adapter (35) using wrench (size 25 mm).



5. Tighten a 1/2" male threaded pipe into the outlet port & unscrew Air Motor Assembly anticlockwise. Carefully remove Air Motor from Barrel (63).

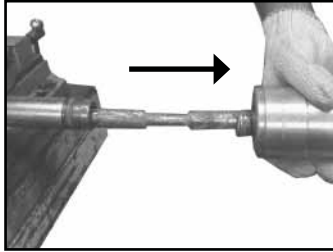
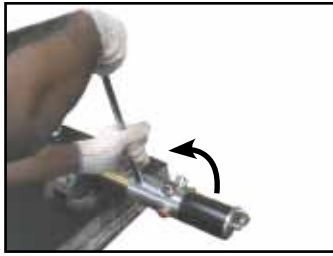

6. Support Pump Cylinder (51) on a V block & insert a pin punch vertically into the hole of Pump Cylinder (51). Tap lightly with a hammer to drive out lower Slotted Spring Pin (44) taking care not to bend the Extension Rod (46).



7. Unscrew Pump Cylinder (51) & remove upper Steel Ball (47) & Non Return Spring (48).

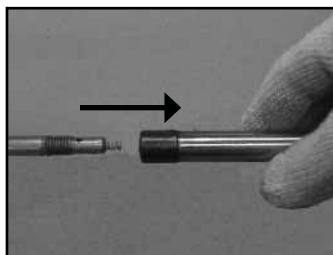

Non return Spring



Steel Ball



8. Hold Filter Tube (57) in vice. Using two wrenches (size 28 mm), hold Bottom Coupler (54) & unscrew Top Coupler (52). Remove Slide Bush (53).



Slide Bush



9. Unscrew Bottom Coupler (54) with wrench (size 28 mm) & remove Guide Bush (56).



Guide Bush



10. Replace the Repair Kit (KIT/BTM/RPG) as mentioned in Table 5 - Page 17, by following the steps 1-9 in reverse order taking care of the points below:

- **Pump Cylinder (51) has a pin-hole end that must face upwards; towards Extension Rod (46).**
- **Slide Bush (53) has a slotted end that must always face upwards; towards Top Coupler (52).**

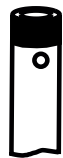

- **Replace Part No. 51, 52, 53 & 55 TOGETHER as a set even if there is a need to replace only one of these parts. Apply minor grease on all the moving parts before assembly. Also, ensure movement of part 51, 52 & part 53, 55 is smooth.**

Drive Section Kit Replacement (Refer to Table 6 - Page 18)

1. Hold Barrel (63) in a soft-jaw vice. Pull out Filter Cap (62) by hand.



2. Unscrew Nyloc Nut (61) using T-handle (size 10 mm) & also remove Piston Washer (60) from the end of Filter Tube (57).



3. Remove the outlet adapter (35) using wrench (size 25 mm).



4. Tighten a 1/2" male threaded pipe into the outlet port & unscrew Air Motor Assembly anticlockwise. Carefully remove Air Motor from Barrel (63).

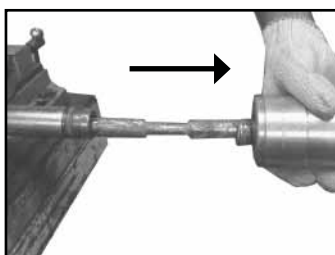

5. Support Extension Rod (46) on a V block & insert a pin punch vertically into the hole of Connector (45). Tap lightly with a hammer to drive out upper Slotted Spring Pin (44) taking care not to bend Extension Rod (46).



6. Unscrew Connector (45) with wrench (size 14 mm) & separate Air Motor Assembly from Extension Rod (46).



7. Hold Air Motor Assembly in a soft-jaw vice. Loosen both Coupling Nuts (2) using wrench (size 21 mm).



8. Remove Bend Pipe (1) along with both Coupling Nuts (2) & Sealing Rings (3). Unscrew Exhaust Valve (23) with an adjustable wrench.



9. Unscrew both Bends (4) using wrench (size 13 mm).



10. Lightly tap Cylinder (10) with a plastic hammer & unscrew it .



11. Unscrew Inlet Cover Adapter (34) using wrench (size 25 mm).



12. Connect a caliper wrench into the holes on inlet Cover (32) & unscrew it.



13. Unscrew both Pushers (15) using wrench (size 25 mm).

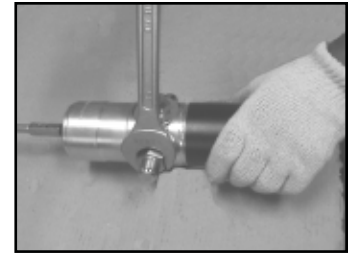

14. Remove both Pushers (15), Springs (17), Pusher Nuts (18) & Pusher Buttons (19).



15. Using two wrenches (size 10 mm), hold Plunger Rod (9) & turn Connecting Rod (43) anticlockwise. This will unscrew Connecting Rod (43).



16. Remove Connecting Rod (43) along with Washer (42), Spring (41), Seal Support (40), Seals (39) & Slider Guide (38).



- If Connecting Rod (43) is still attached to the inner rod of Slider (30), hold the inner rod in a vice & unscrew Connecting Rod (43) with wrench (size 10 mm).**



17. Remove Slider (30) with a tweezer.



18. Open the two Screws (29) with a Philips screwdriver & remove Clip (28).



19. Remove Nylon Slider (27).



20. Remove Slider Guide (26).



21. Remove Seat (25) & Paper Seal (24). Clean the bottom surface thoroughly.



22. Replace the Repair Kit (KIT/TP/RPG) as mentioned in Table 6 - Page 18, by following the steps 1-21 in reverse order taking care of the points below:

- **Ensure all mating surfaces are clean before reassembly. Apply minor grease on all mating surfaces, O Rings & moving parts before reassembly.**



Clean & apply grease

- **Ensure that height of Nylon Slider (27) is approx. 5.3 - 5.7 mm. Also, hollow portion of Nylon Slider should rest evenly on top of Seat (25).**

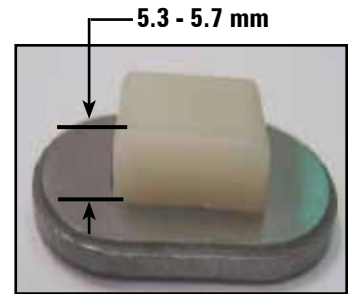

- **When fitting Pushers (15), see through Inlet Cover (32) & ensure Pusher Buttons (19) are installed in centre position. Also ensure that Clip (28) is tight & Nylon Slider (27) moves smoothly.**



- **When fitting Plunger Rod (9) & Connecting Rod (43), apply locking fluid on the inner rod of Slider (30).**



- **Conical side of Seals (39) must face upwards. Assemble them with Slider guide (38), Seal Support (40) & mount them as a set on Connecting Rod (43).**

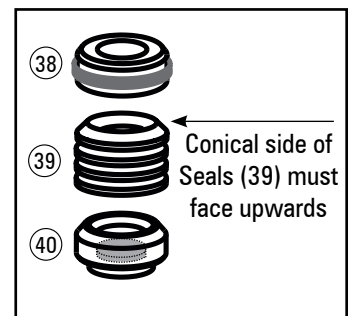

EXPLODED VIEW

PUMP ASSEMBLY

Fig. 6

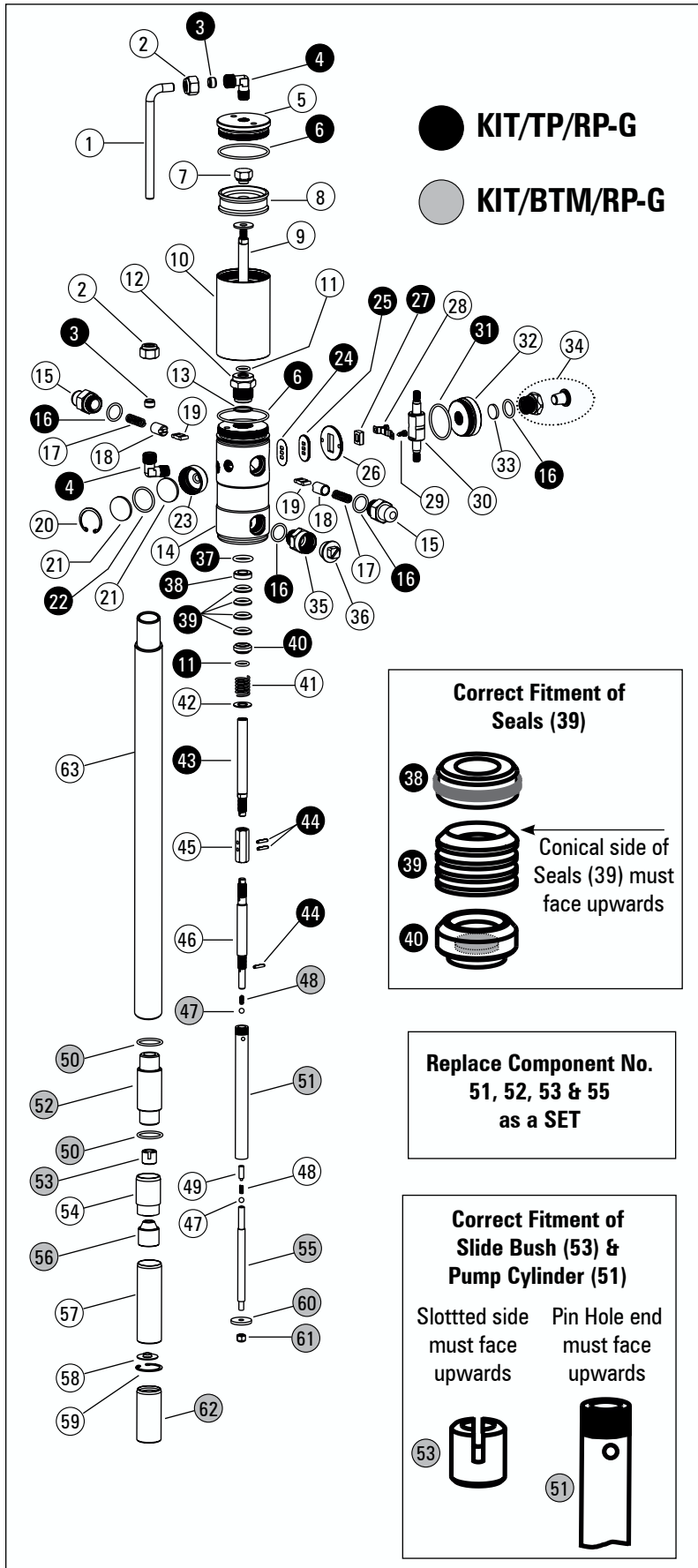

DRUM COVER, FOLLOWER PLATE, HOSE, Z SWIVEL & GREASE CONTROL VALVE

Fig. 7

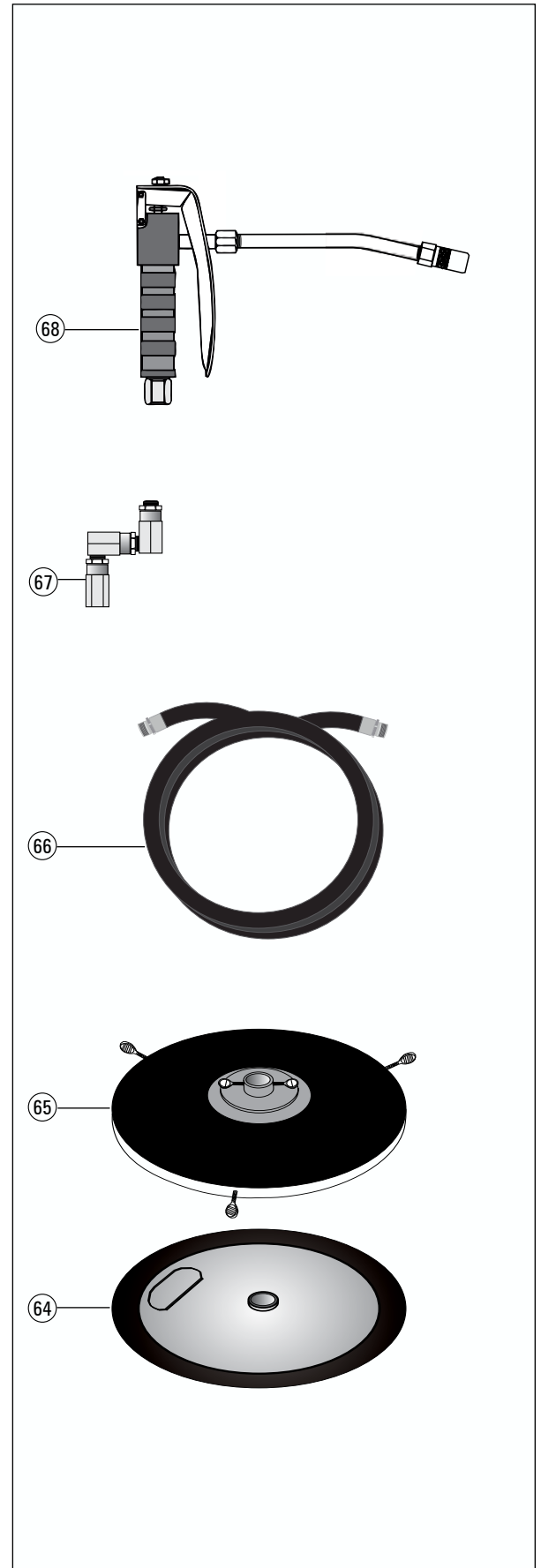

PARTS LIST

PARTS LIST FOR PUMP ASSEMBLY

Table 1

REF. NO. FROM EXPLODED VIEW	DESCRIPTION	QUANTITY
1	Bend Pipe	1
2	Coupling Nut	1
3	Sealing Ring	2
4	Bend	2
5	Cylinder Cover	1
6	O Ring BS141	2
7	Plunger Nut	1
8	Rubber Plunger	1
9	Plunger Rod	1
10	Cylinder	1
11	O Ring BS614	2
12	Rod Guide	1
13	O Ring	1
14	Housing	1
15	Pusher	2
16	O Ring BS617	4
17	Pusher Spring	2
18	Pusher Nut	2
19	Pusher Button	2
20	Circlip	1
21	Filter (B)	2
22	O Ring BS121	1
23	Exhaust Valve	1
24	Paper Seal	1
25	Seat	1
26	Slider Guide	1
27	Nylon slider	1
28	Clip	1
29	Self Tapping Screw	2
30	Slider	1
31	O Ring BS129	1
32	Inlet Cover	1
33	Filter (B)	1
34	Air Inlet Adapter	1
35	Outlet Adapter	1
36	Adapter Cap	1
37	O Ring BS115	1
38	Slider Guide	1
39	Seal	4
40	Seal Support	1
41	Spring	1

REF. NO. FROM EXPLODED VIEW	DESCRIPTION	QUANTITY
42	Washer	1
43	Connecting Rod	1
44	Slotted Spring Pin	3
45	Connector	1
46	Extension Rod	1
47	Steel Ball (7/32")	2
48	Non Return Spring	2
49	Valve	1
50	O ring (BS812)	2
51	Pump Cylinder	1
52	Top Coupler	1
53	Slide Bush	1
54	Bottom Coupler	1
55	Piston Rod	1
56	Guide Bush	1
57	Filter Tube	1
58	Filter Washer	1
59	Filter Circlip	1
60	Piston Washer	1
61	Nyloc Nut	1
62	Filter Cap	1
63	Barrel	1

**PARTS LIST FOR DRUM COVER, FOLLOWER PLATE,
HOSE, Z SWIVEL & GREASE CONTROL VALVE**

Table 2

REF. NO. FROM EXPLODED VIEW	DESCRIPTION	QUANTITY
64	Follower Plate	1
65	Drum Cover	1
66	Hose	1
67	Z Swivel	1
68	Grease Control Valve	1

TROUBLESHOOTING

(Refer to Maintenance & Repair - Page 7)

Table 3

PROBLEM	POSSIBLE CAUSE	SOLUTION
Pump operates, but does not dispense any grease	Grease is too thick / too cold	Store grease in a warm place
	Air pockets in grease	Shake the Grease bucket & manually force down the Follower Plate (64) to remove air pockets
	Dent in the Grease Bucket restricting movement of Follower Plate (64) leading to formation of air pockets in the bucket and inefficient working	Get the dent removed to ensure proper movement of Follower Plate (64)
Pump not working / less discharge	Inlet pressure is too less	Increase inlet pressure. It must be at least 30 PSI (2 BAR)
	Nylon Slider (27) is jammed / overtight	Refer to Drive Section Kit Replacement - Page 8 1. Check for any build-up edge on Clip (28) & tighten it again. Make sure the movement of Nylon Slider (27) is neither very loose nor very tight 2. If needed, replace Nylon Slider (27). Also replace the Paper Seal (24), Seat (25) & Slider Guide (26) to ensure the best fitting
	Piston / Piston Rod / Plunger jammed. NOTE Especially check Extension Rod (46), Cylinder (51), Top Coupler (52), Slide Bush (53) & Piston Rod (55) as shown in EXPLODED VIEW	Refer to Pumping Section Kit Replacement - Page 6 1. Remove suction tube. Disconnect Air Motor Assembly from Pumping Section by removing the upper Slotted Spring Pin (44) from Connector (45) 2. Supply input air to Air Motor. If it works properly without the barrel assembly, then the problem lies with the pumping section. Otherwise check the Air Motor for smooth movement 3. After locating the faulty section, check the respective Piston / Plunger & the associated washers & seals for any overlap or wear & tear. Replace the defective parts from Repair Kit 4. Ensure to replace the moving parts having close tolerances (such as Piston & Cylinder alongwith Non Return Springs & balls) as a SET to ensure the best fitting
Pump continues to operate even after the trigger of Grease Control Valve (68) has been released	Leakage in the assembly	Check all the connections to ensure they are air tight. Use thread sealant. Check O rings & seals for damage. Replace the defective parts from Repair Kit
Grease comes through the air Exhaust Valve (23)	Grease leaks into the Air Motor	Check Slider Guide (38), O Ring (37), lower O Ring (11), Seals (39) & Seal Support (40) for wear & tear. Replace the damaged parts from Repair Kit
Air passes directly from inlet to the outlet & pump does not work	Nylon Slider (27) is jammed / overtight	Refer to Drive Section Kit Replacement - Page 8 1. Check for any build-up edge on Clip (28) & tighten it again. Make sure the movement of Nylon Slider (27) is neither very loose nor very tight 2. If needed, replace Nylon Slider (27). Also replace the Paper Seal (24), Seat (25) & Slider Guide (26) to ensure the best fitting
Discharge suddenly stopped while the pump was running	Seals / O Rings Damage	Check all seals / O Rings & replace the damaged parts from Repair Kit
	Chip / Other foreign particles get clogged at discharge coupler	Open the coupler, remove all foreign particles / chips & reassemble properly
	Clogging of Filter Tube (57)	Open Filter Tube (57), clean it & reassemble it properly

**REPLACEMENT & SERVICE PARTS PROGRAM FOR GREASE RATIO PUMP
(Refer to Exploded View - Page 12)**

Table 4

REPLACEMENT PARTS PROGRAM

REF. NO. FROM EXPLODED VIEW	PART NO.	DESCRIPTION	QUANTITY
64	FLP/241-288/6	GP1 Follower Plate	1
	FLP/322-380/6	GP2 Follower Plate	1
	FLP/550-602/6/GP3	GP3 Follower Plate	1
65	DC/GP1/BL	GP1 Drum Cover	1
	DC/GP2/BL	GP2 Drum Cover	1
	DC/GP3/BL	GP3 Drum Cover	1
66	HOSE/GRP/84/B	Hose, BSP Threads	1
	HOSE/GRP/84/N	Hose, NPT Threads	1
67	HFC/1-4F/1-4M/B	Z Swivel, BSPT Threads	1
	HFC/1-4F/1-4M/N	Z Swivel, NPT Threads	1
68	APG/04/1-4F/B	Grease Control Valve, BSPT Threads	1
	APG/04/1-4F/N	Grease Control Valve, NPT Threads	1

SERVICE PARTS PROGRAM (Pumping Section Kit - KIT/BTM/RP-G)

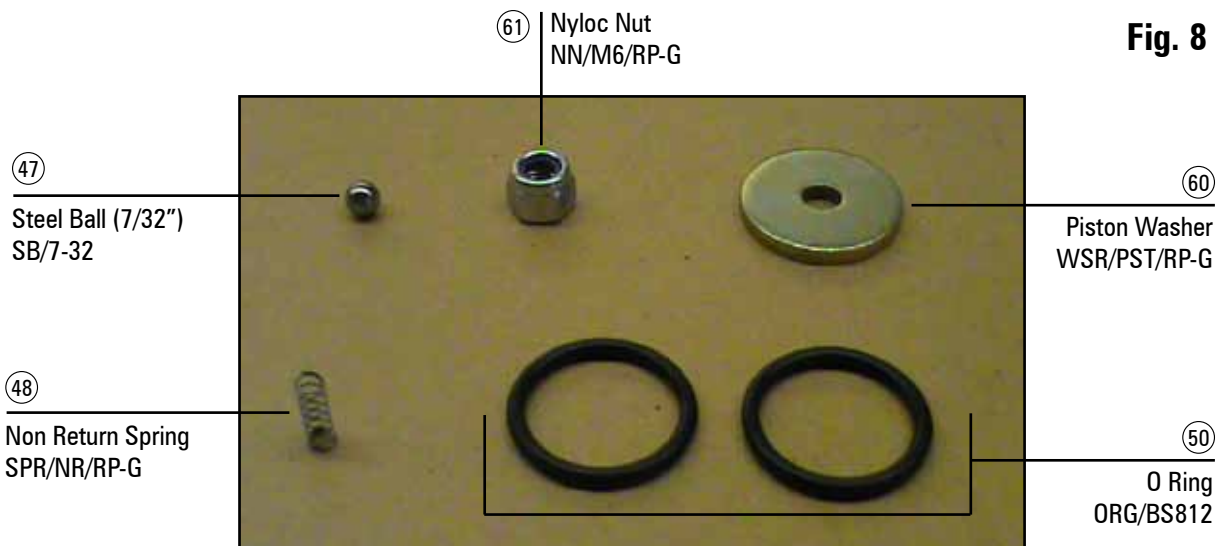

Rod & Cylinder Assembly
ROD/CYL/RP-G

**Component (51) (52) (53) (55)
must be replaced TOGETHER
even if only one of these
component need replacement**

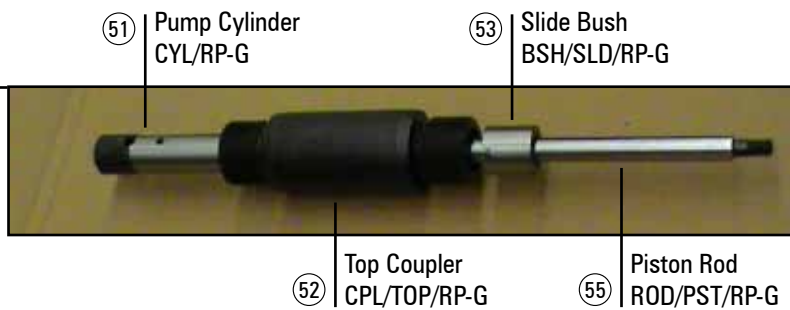

Table 5

KIT PART NO.	KIT DESCRIPTION	CONSTITUENT PART NO.	PART DESCRIPTION	REFERENCE NO. FROM EXPLODED VIEW	QTY. PER KIT
KIT/BTM/RP-G	PUMPING SECTION KIT	SB/7-32	Steel Ball (7/32")	47	1
		SPR/NR/RP-G	Non Return Spring	48	1
		ORG/BS812	O Ring	50	2
		ROD/CYL/RP-G	Pump Cylinder (CYL/RP-G)	51	1
			Top Coupler (CPL/TOP/RP-G)	52	1
			Slide Bush (BSH/SLD/RP-G)	53	1
			Piston Rod (ROD/PST/RP-G)	55	1
		BSH/RP-G	Guide Bush	56	1
		WSR/PST/RP-G	Piston Washer	60	1
NN/M6/RP-G	Nyloc Nut	61	1		
IC/FLT/RP-G	Filter Cap	62	1		

SERVICE PARTS PROGRAM (Drive Section Kit - KIT/TP/RP-G)

Fig. 11



Fig. 12

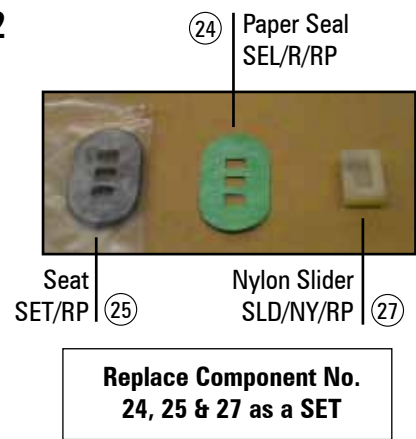

Fig. 13

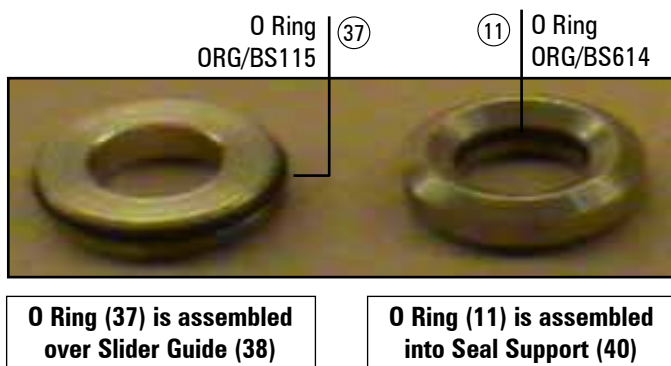

Fig. 14

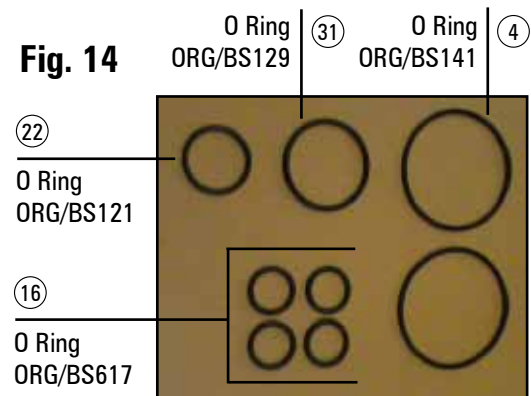

Table 6

KIT PART NO.	KIT DESCRIPTION	CONSTITUENT PART NO.	PART DESCRIPTION	REFERENCE NO. FROM EXPLODED VIEW	QTY. PER KIT
KIT/TP/RP-G	DRIVE SECTION KIT	SR/B/RP	Sealing Ring	3	2
		BEND/90/RP	Bend	4	2
		ORG/BS141	O Ring	6	2
		ORG/BS614	O Ring	11	1
		ORG/BS617	O Ring	16	4
		ORG/BS121	O Ring	22	1
		SEL/P/RP	Paper Seal	24	1
		SET/RP	Seat	25	1
		SLD/NY/RP	Nylon Slider	27	1
		ORG/BS129	O Ring	31	1
		ORG/BS115	O Ring	37	1
		GUD/SEL/RP	Slider Guide	38	1
		SEAL/RP	Seal	39	4
		SU/SEL/RP	Seal Support	40	1
		ROD/CNR/S/RP	Connecting Rod	43	1
SSP/3/0.6/15.3	Slotted Spring Pin	44	3		

SPECIFICATIONS

Table 7

MODEL	GP1	GP2	GP3
Bucket Capacity	20-30 Kg / 5 Gal / 25-50 lbs.	50-60 Kg / 16 Gal / 120 lbs.	180 Kg / 55 Gal / 400 lbs.
Suction Tube Length	17.32" (440 mm)	28.74" (730 mm)	37.38" (950 mm)
Suction Tube Dia.	1.18" (30mm)		
Flow Rate	1.10 Kg / min. (2.42 lbs / min)		
Working Pressure	10 BAR (150 PSI)		
Maximum Outlet Pressure	500 BAR (7500 PSI)		
Air Inlet Connection	1/4" (F)		
Pump Outlet Connection	1/4" (F)		
Air Consumption	230 LPM (61 GPM)		
Hose Length*	7' (84")		
Noise Level	81 db		

* IT MAY VARY FROM ONE MODEL TO ANOTHER



- Always wear protection gear like safety goggles, gloves, apron, and ear plugs while operating the pump
- Never let any body part come in front of, or in contact with the control outlet
- Always cut off air supply after use, so that media cannot leak in case any of the pump component fails
- Before switching the air supply on, check hoses for sign of wear, leak or loose fittings. Replace as necessary
- Do not smoke near the pump. Do not use the pump near a source of spark / open flames
- When changing the working fluid, at least 1 litre of new fluid should be discarded to avoid mixing of fluids
- Pump should NOT be operated for more than 4 hrs continuously
- Pump must be supplied with CLEAN & DRY compressed air via an FRL unit
- Before attempting any repair of this product, disconnect air supply and then squeeze control valve trigger to release fluid pressure
- Use only genuine factory parts for repair

WETTED COMPONENTS

Steel, Brass, Aluminium, & Polyurethane

RECOMMENDED USE

With light and self collapsing grease up to NLGI No. 2